

D49 OBDII GNSS Tracker

User Manual

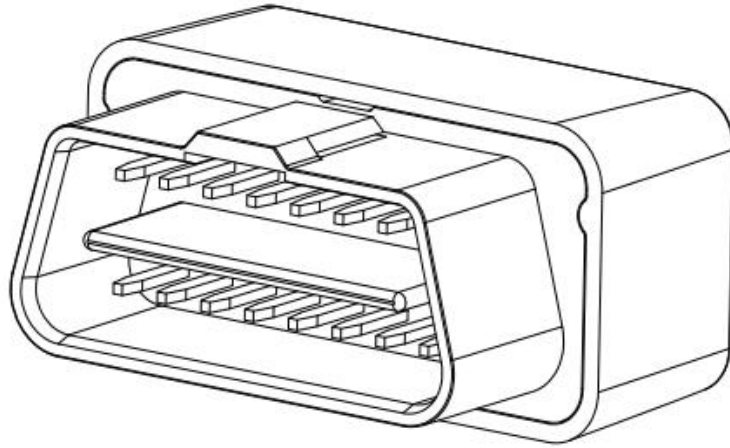

Email: support@Incoon.com

Website: www.Incoon.com

WhatsApp Group:



Tracking Platform: Incoon.com/download



Interface

Appearance



2.2 LED indicators

1) power indicator(red)

Slow flashing	full charge/working normally
Solid red	charging
No light	power off/low battery/internal fault/sleep mode

2) 4G indicator(green)

Quick flashing	4G initializing
Slow flashing	receive 4G signal normally
Solid green	in communication with phones link up
No light	no 4G signal or no SIM card

3) GPS indicator(blue)

Quick flashing	searching GPS signal
Solid blue	positioned
No light	not working/sleep mode

Activate device

ACTIVATION STEPS

01 Download **LNCOON** from App Store or Google Play

02 **Register** a tracking account and log in

03 Click "+" and input **IMEI number** to add new device
(You can find the IMEI on the box or device body)

04 Click "**Top up**" and get a subscription plan

05 **Plug in the tracker** into OBD-II Port on your car

Ask Any Question: Support@Lncoon.com

NOTE: If [top-up] fails on LNCOON APP, please go to lncoon.com to purchase the tracker subscription plan.

Alerts

Vibrating alert

When the tracker detects abnormal vibration, it will send alert to the APP.

Power cut-off alert

when the electricity supply of device is cut off, it will activate power cut-off alert. Then the device will send "power cut-off alert" to the APP.

Geo-fence alert

After setting the fence area on the platform and selecting the trigger conditions of the alarm, the device will send corresponding in and out alert to the platform according to the trigger conditions when the device enters and exits the geo-fence.

Over-speed alert

The car speed threshold can be set by platform. when vehicle speed over the setting threshold , the overspeed alert will be triggered.

Driving behavior analysis

Receive alerts when any of 4 kinds of dangerous driving behavior (harsh acceleration, harsh braking, harsh cornering, collision) is detected.
NOTE: The above functions are disabled by default and need to be enabled through the platform or APP.

Command

Usually we send commands to make the device work, such as turning off the LED light on the device, setting the positioning interval, the speed threshold of the speeding alarm, etc.

1. Where to send the command?

APP List → More Action → Command → User-defined

Tips: how to open more action?

Click the three dots next to Playback to enter the more action page.

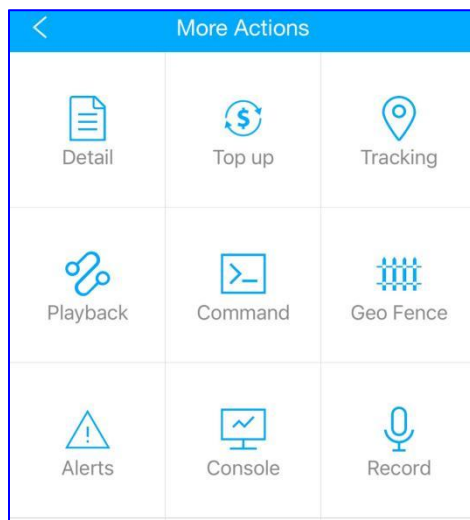
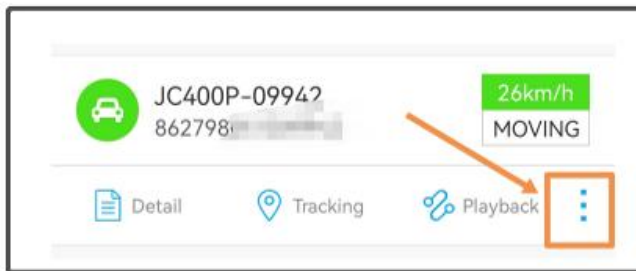

On the **More Actions** page, you can also click to set GEO FENCE Zone, Playback, Record etc.

2. Where to get command list?

Go to [Incoon.com](https://incoon.com)

Find it on: **Setup** → **Download User Manual**

Then find the model D49/V5405 and download command.

For example, if you want to set the overspeed alert, you can enter the command in User Defined and save it.

parameter: [SPEED,SW,M,V,T#](#)

Parameter explanation:

[SW=ON/OFF](#), Open or close the overspeed alarm, default: OFF

[M=0](#). M can only be 0, which means receiving warning information on the APP.

[V=1-255](#) (km/h), speed limit, default: 50 (km/h);

[T=5-600](#) (seconds), detection time interval, default: 20 (seconds)

So you can enter: [SPEED,ON,0,100,60#](#)

This means that the device turns on the speed alert and will detect the current speed of the car every 60 seconds. When the device detects that the speed exceeds 100 km/h, it will upload the overspeed alert to the APP.

Any question about command please contact support@incoon.com

Main Functions

● Real Time Location

- Check where the tracker is, and get actual address.

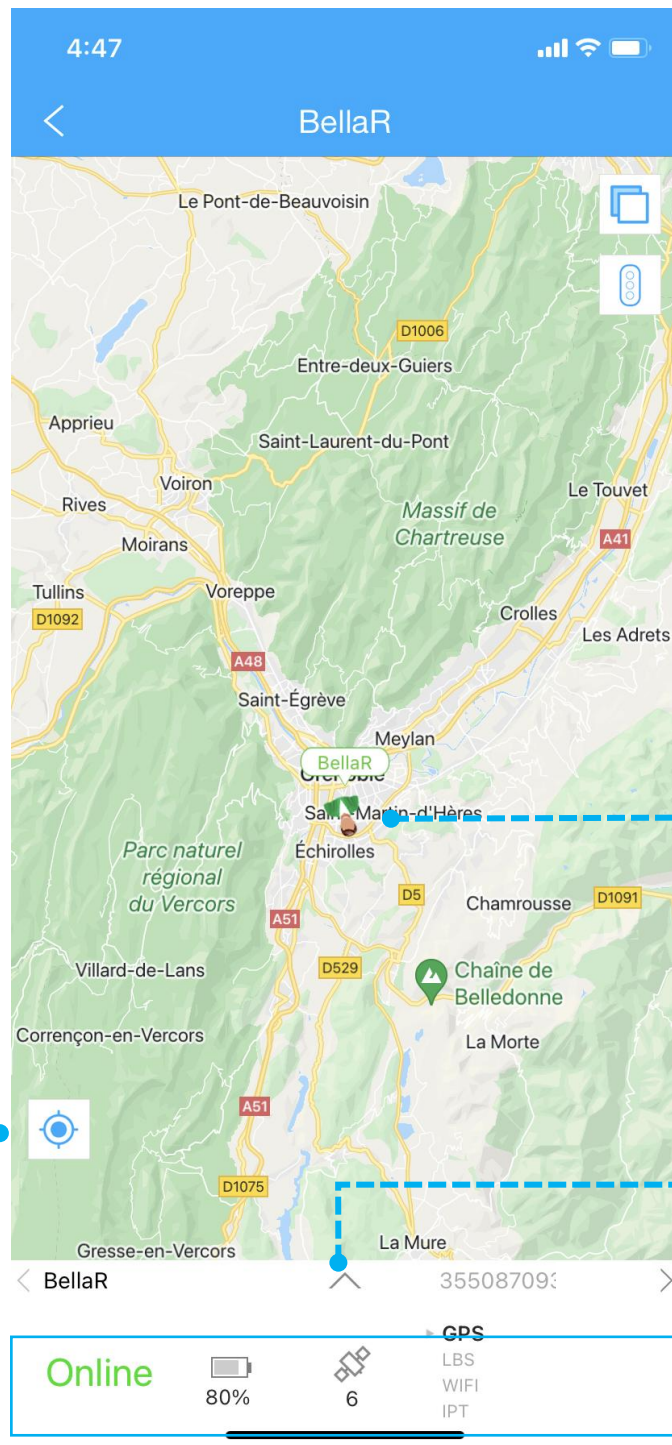

Map Type

Traffic

1. Click to refresh the current device location
2. Click again to view the current phone location.

The Tracker

Swipe up the panel to see more information

Device Status

● Tracking

- Tapping “Tracking” button to enter the Track page.

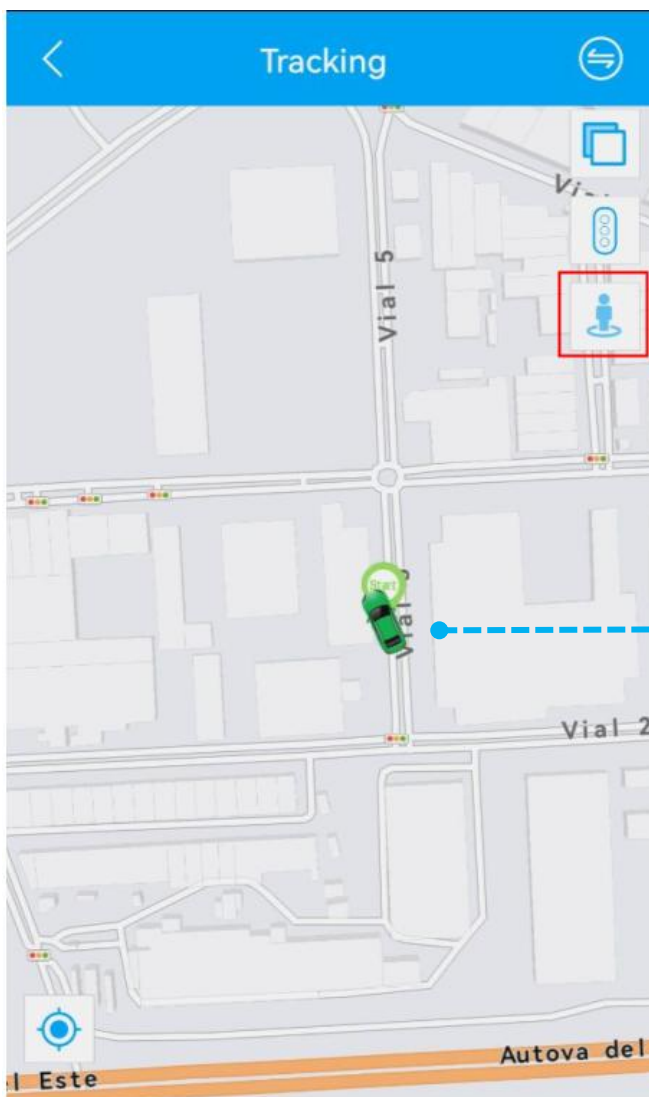
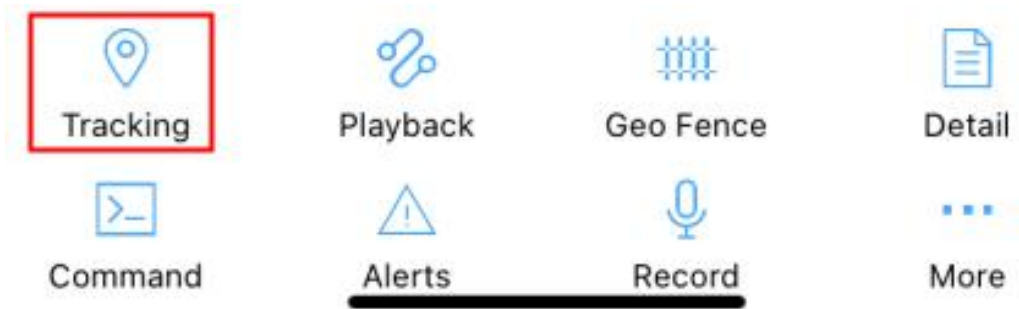

Click here for 3D Street View

The Tracker

OB22-34147 359647090934147

Stopped 2hr OFF 10

2022-04-28 13:01:09 Last Positioning 2022-04-28 15:36:10 Last Update

North 78m,Eurosanex,Vial 5 46380 Chestre Spain

- **Navigate to device location**

1. Click [more] from the panel to find [Navigation]

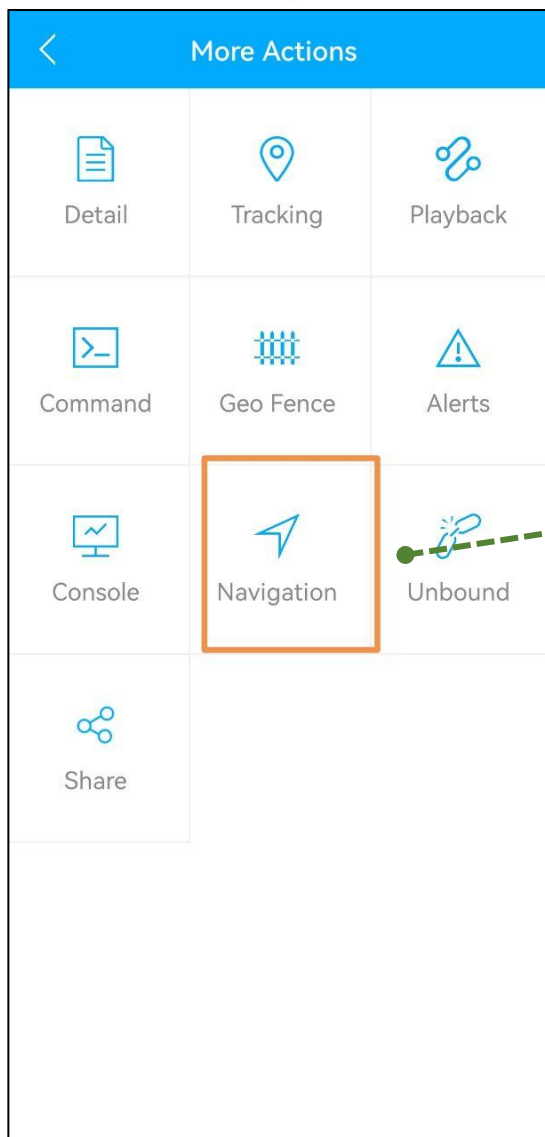

Click [Navigation] to navigate from the current phone location to the device location

● History Playback

- Tapping “Playback” button to enter Trips page.



- Choose a date you want to playback and click “OK” button

- Tap on  to play the history.

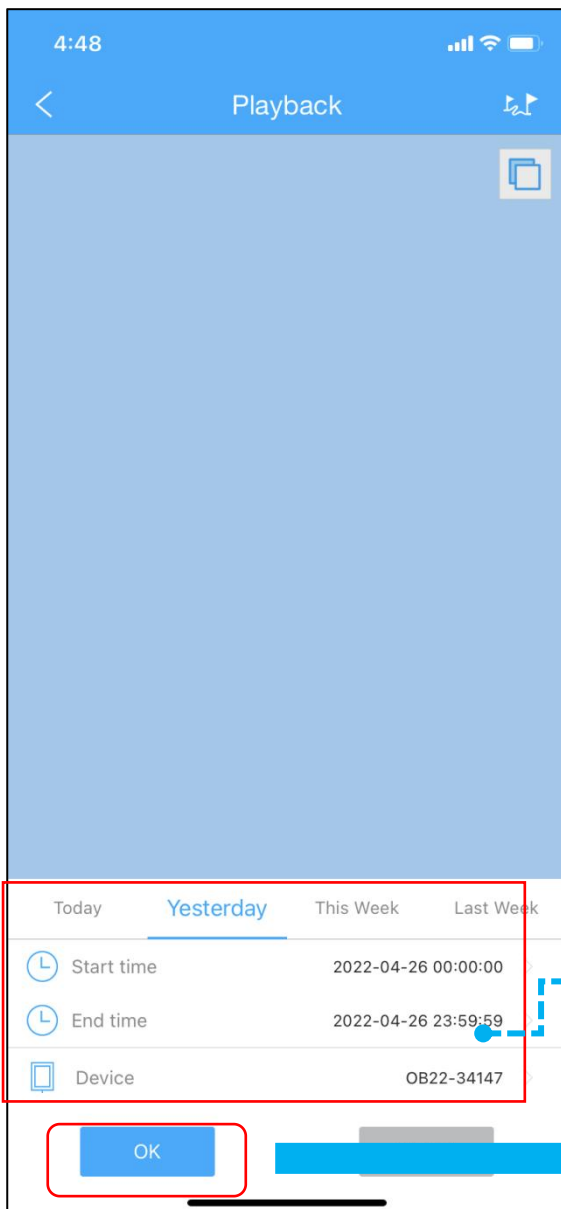

Select Date Range

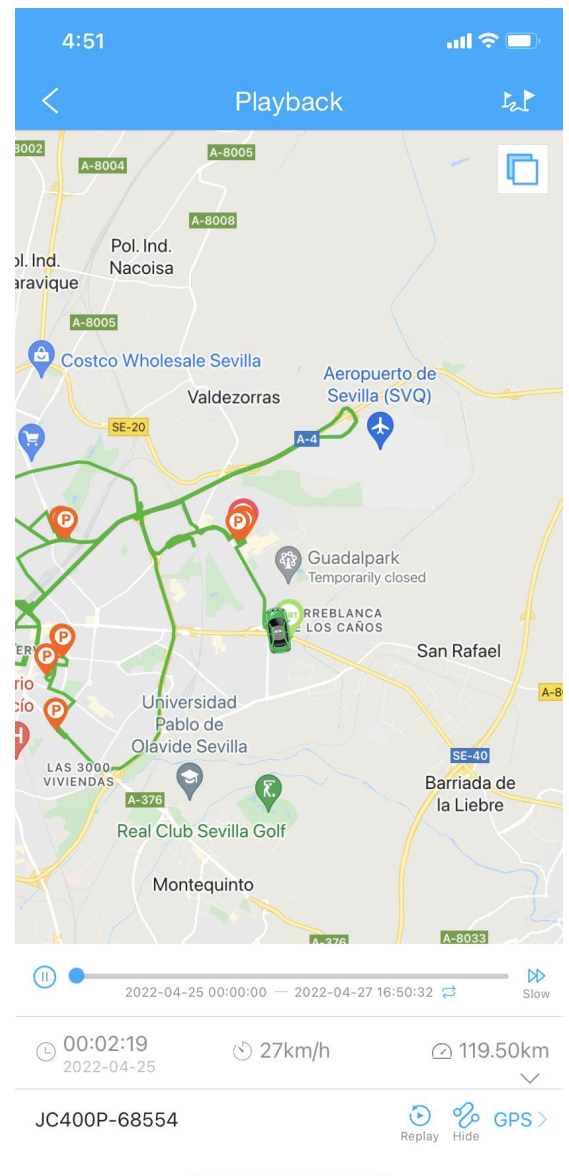

● Geo-Fence

- Tapping “Geo Fence” button to enter Fence page.

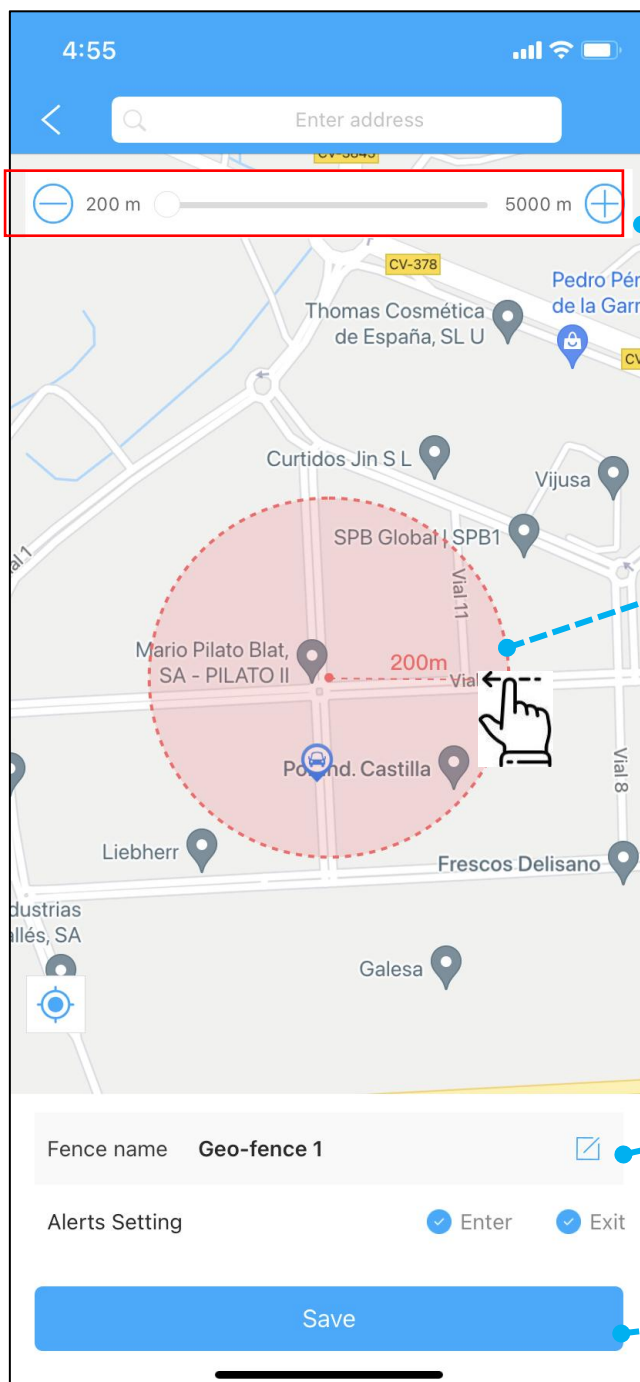

Slide to change the radius

Swipe to move the fence

Edit Fence Name

Save Fence

Battery safety Information

please observe the following battery safety usage precautions:

- Risk of explosion if the battery is replaced by an incorrect type ;
- Disposal of a battery into fire or a hot oven, or mechanically crushing or mechanically crushing or cutting of a battery, that can result in an explosion;
- Leaving a battery in an extremely high temperature surrounding environment that can result in an explosion or the leakage of flammable liquid or gas;
- A battery subjected to extremely low air pressure that may result in an explosion or the leakage of flammable liquid or gas.